

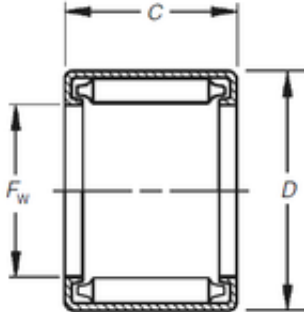

BEARING USA CORP.

Timken B-1812 needle roller bearings



Bearing No. B-1812

Size	28.575x34.925x19.05 mm
Bore Diameter	28,575 mm
Outer Diameter	34,925 mm
Width	19,05 mm
Fw	28,575 mm
D	34,925 mm
C	19,05 mm
Weight	0,035 Kg
Basic dynamic load rating (C)	27,3 kN
Basic static load rating (C0)	58,3 kN
(Grease) Lubrication Speed	2500 r/min

B-1812 Bearing 2D drawings and 3D CAD models